

Elastomer-rugók

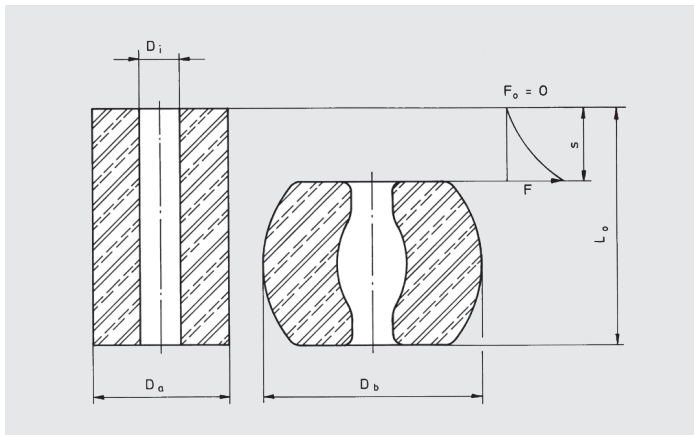

Gumirugók

DIN ISO 10069

Anyag: Chloropren-elastomer (CR)
keménység 70 ± 3 Shore A

Megengedett rugóút $s_{max.} = 0,35 L_0$
Tömörödés az L_0 3 – 5 % -a
A gumirugók nagy rugóutaknál alkalmazhatók.
Hőállóság 80°C -ig
rövid ideig 120°C -ig

Rend. szám
a mérettel
kiegészítve

D_a	D_i	L_0	D_b	D_1	Rend. sz. SZ 8500. <input type="checkbox"/> x <input type="checkbox"/>
16	6,5	12	22	28	016 x 012
		16			016 x 016
		20			016 x 020
		25			016 x 025
20	8,5	16	27	32	020 x 016
		20			020 x 020
		25			020 x 025
		32			020 x 032
25	10,5	20	34	36	025 x 020
		25			025 x 025
		32			025 x 032
		40			025 x 040
32	13,5	32	43	45	032 x 032
		40			032 x 040
		50			032 x 050
		63			032 x 063
40	13,5	32	54	56	040 x 032
		40			040 x 040
		50			040 x 050
		63			040 x 063
		80			040 x 080
50	17	32	68	71	050 x 032
		40			050 x 040
		50			050 x 050
		63			050 x 063
		80			050 x 080
		100			050 x 100
63	17	32	85	90	063 x 032
		40			063 x 040
		50			063 x 050
		63			063 x 063
		80			063 x 080
		100			063 x 100
80	21	32	108	112	080 x 032
		40			080 x 040
		50			080 x 050
		63			080 x 063
		80			080 x 080
		100			080 x 100
		125			080 x 125
100	21	32	135	140	100 x 032
		40			100 x 040
		50			100 x 050
		63			100 x 063
		80			100 x 080
		100			100 x 100
125	27	32	169	180	125 x 032
		40			125 x 040
		50			125 x 050
		63			125 x 063
		80			125 x 080
		100			125 x 100
		125			125 x 125
		160			125 x 160

Elastomer-rugók

Beépítési példák

Az SZ8500 gumirugók erő-út diagramja

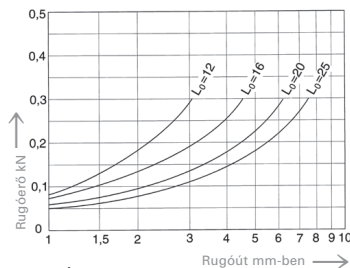
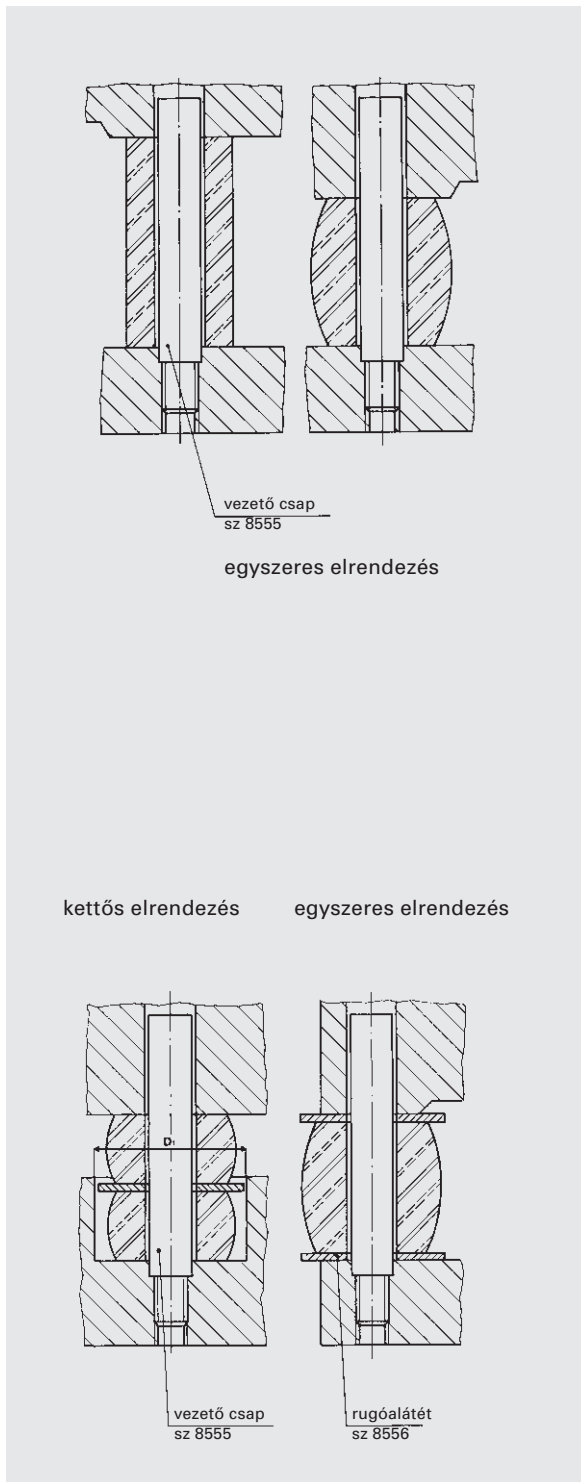

1. Ábra Rugó CR 16

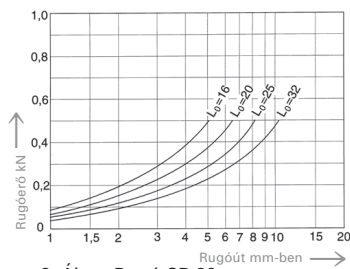

2. Ábra Rugó CR 20

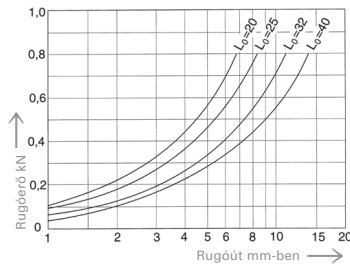

3. Ábra Rugó CR 25

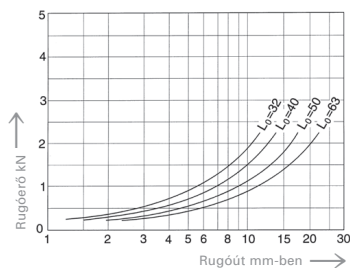

4. Ábra Rugó CR 32

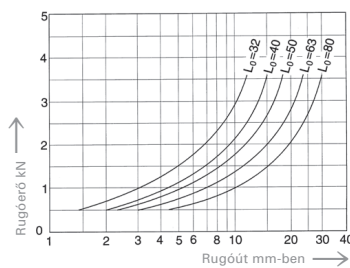

5. Ábra Rugó CR 40

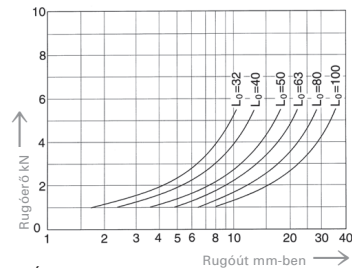

6. Ábra Rugó CR 50

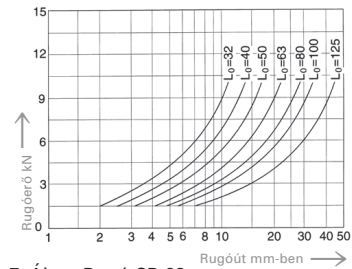

7. Ábra Rugó CR 63

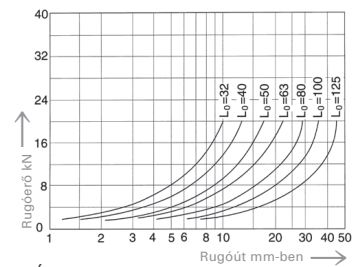

8. Ábra Rugó CR 80

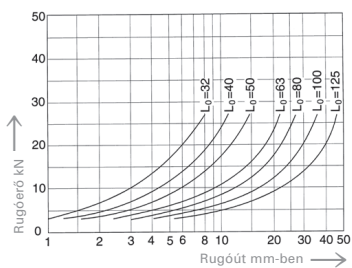

9. Ábra Rugó CR 100

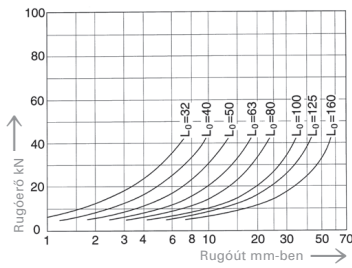

10. Ábra Rugó CR 125